

Distribution Automation Handbook

Section 8.5 MV Feeder Short-circuit Protection

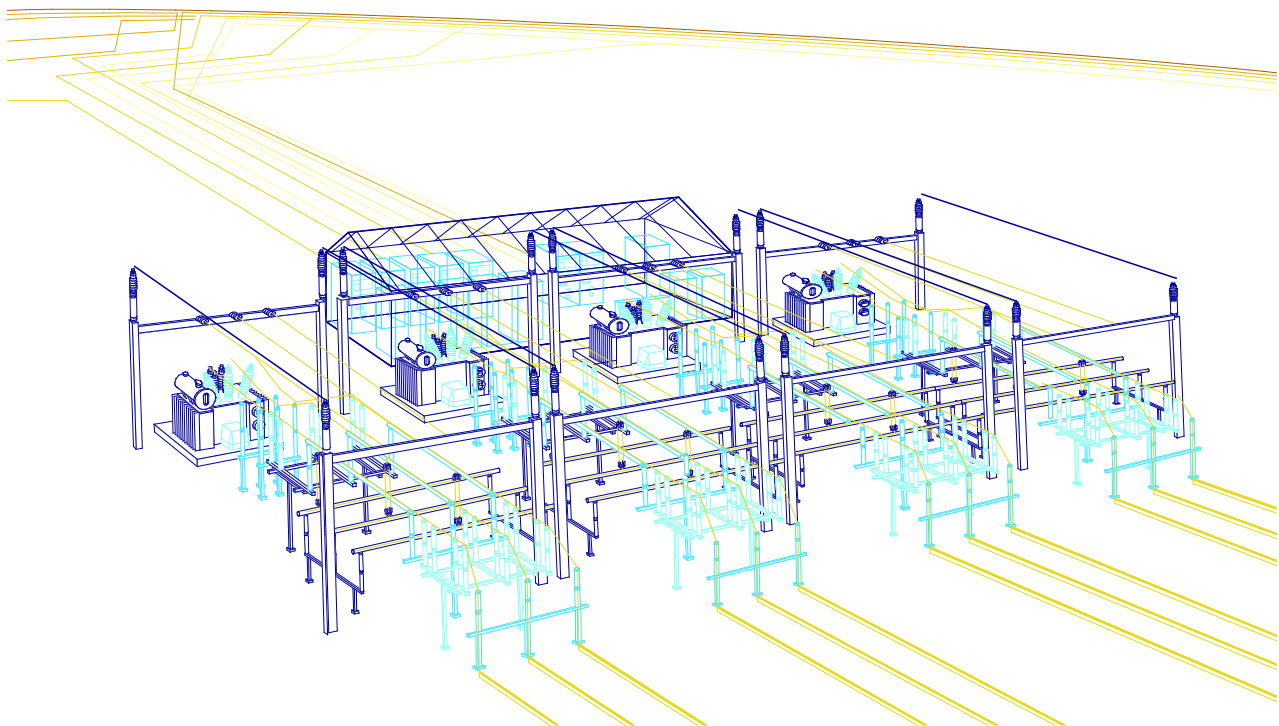

Contents

8.5	MV Feeder Short-circuit Protection.....	3
8.5.1.1	FAULTS AND ABNORMAL CONDITIONS.....	3
8.5.1.2	FAULT STATISTICS	3
8.5.1.3	NON-DIRECTIONAL OVERCURRENT RELAYS.....	5
8.5.1.4	CHARACTERISTICS OF OVERCURRENT RELAYS.....	7
8.5.1.4.1	Independent Time Overcurrent Relays.....	7
8.5.1.4.2	Dependent Time Overcurrent Relays	8
8.5.1.4.3	IDMT Overcurrent Relays.....	11
8.5.1.5	BLOCKING-BASED OVERCURRENT PROTECTION	11
8.5.1.6	PARALLEL FEEDERS	12
8.5.1.7	DIRECTIONAL OVERCURRENT RELAYS.....	13
8.5.1.8	LONGITUDINAL DIFFERENTIAL PROTECTION SYSTEMS	14
8.5.1.9	THERMAL OVERLOAD PROTECTION	15

8.5 MV Feeder Short-circuit Protection

A short circuit is a serious incident that affects power system components. It is therefore very important that the protection system detects short circuits and trips the associated switching equipment. This chapter is focused on the short-circuit protection of MV feeders. We will usually use the term *feeder* to designate an electric power circuit in a radially operated distribution systems and reserve the term *line* for an electric power circuit in an interconnected (or meshed) power network.

The terms *overcurrent relay* and *overload relay* will be used to distinguish between two major types of relays. An overcurrent relay is designed to detect short circuits on the feeder while the overload relay is used to protect the feeder against overheating.

8.5.1.1 *Faults and Abnormal Conditions*

At the fault location, there is often a high-power *electrical arc* that may cause severe damage. All power system components that carry short circuit currents will be subjected to severe *mechanical stress* caused by the electrodynamic forces, which may damage the component or cause another short circuit. All components that carry fault current will be subjected to severe *thermal stress* caused by the Joule losses, which may destroy the mechanical strength of conductors or destroy insulation. A short circuit on a feeder in a radially operated distribution system will cause *customer interruptions*, which are associated with costs both for the customer and for the utility. Last but not least, a short circuit on a feeder will cause voltage dips all over the system and they may cause disconnection of objects that do not withstand the voltage dip.

8.5.1.2 *Fault Statistics*

Most utilities collect fault and outage data in one form or another, especially for the HV and EHV systems. Owners of MV distribution systems often collect failure and outage data and pool their databases with other owners but do not publish their data.

The failure rate of overhead lines with bare conductors normally increases when the system voltage decreases. The reason is that many faults are caused by lightning overvoltages and that the percentage of overvoltages high enough to cause a flashover between the conductor and earth decreases with the increasing system voltage and insulation level.

Figure 8.5.1 shows typical failure rates for overhead lines.

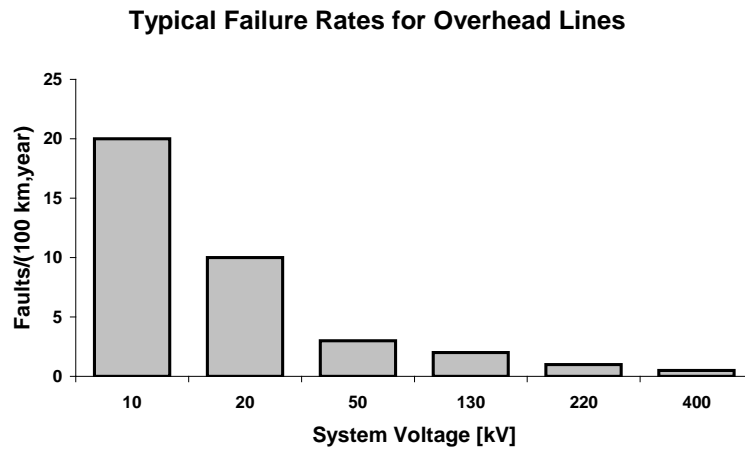

Figure 8.5.1: Typical failure rate of overhead lines

The failure rate shown in Figure 8.5.1 is typical for conditions in northern Europe where the keraunic level in the order of 20 thunderstorm days per year.

Figure 8.5.2 and Figure 8.5.3 show the failure rate for overhead lines and power cables in Sweden as recorded in the period from 1995 to 1997.

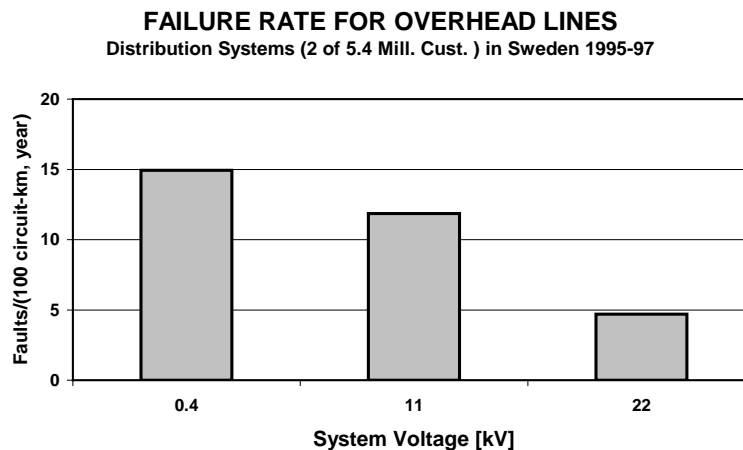

Figure 8.5.2: Failure rate for overhead lines in Sweden

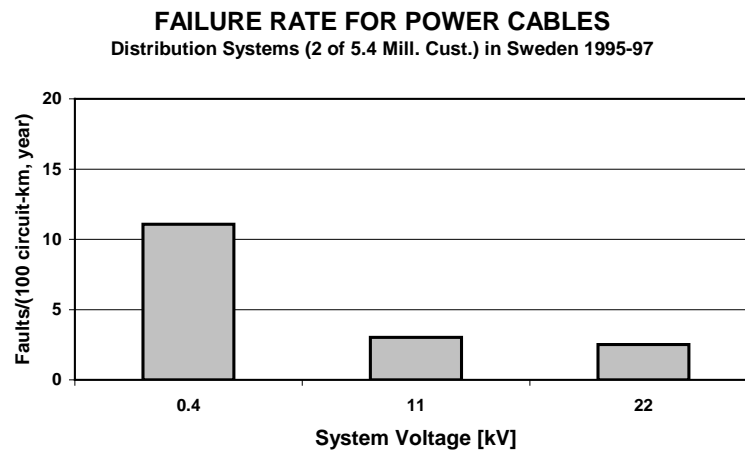

Figure 8.5.3: Failure rate of power cables in Sweden

The failure rate decreases with an increasing system voltage.

8.5.1.3 Non-directional Overcurrent Relays

Overcurrent relays can provide protection against short circuits and earth faults. The secondary current from current transformers energizes overcurrent relays. Overcurrent relays trip the circuit breaker by energizing the trip coil of the circuit breaker. Overcurrent relays may therefore be used to protect components operating at voltages up to the highest levels. The utilities have installed overcurrent relays in very large numbers to provide either the main protection of components or to provide a backup protection to other protection systems.

The pickup current and the delay time can be set to adapt them to fuses and to coordinate them with other protections in the power system. In some applications, however, the use of time-grading alone may not be sufficient to ensure correct operation under all possible system conditions.

The non-directional overcurrent relay is a single-input device. The magnitude of the energizing current determines whether a non-directional overcurrent relay shall operate or not. Other quantities should only have an insignificant influence on the decision to operate or not and on the operating time of the relay.

Figure 8.5.4 shows a three-phase overcurrent feeder protection with one overcurrent relay in each phase. The secondary current from the phase current energizes the overcurrent relay. The overcurrent protection sends the tripping signal to the circuit breaker of the feeder.

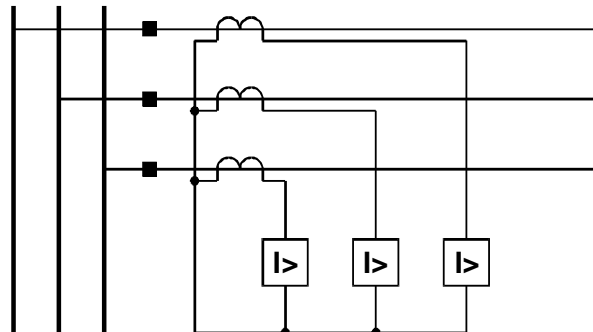

Figure 8.5.4: Three-phase short-circuit protection

The phase overcurrent relays must not operate at the maximum continuous load current. The phase overcurrent relays must not operate at high load currents after an outage. Such currents may be much higher than the maximum continuous load current, especially if the load is electrical space heating. This consideration limits the possibility of using phase overcurrent relays for earth fault protection even in effectively earthed systems where the earth fault current is of the same order of magnitude as the short circuit current. Phase overcurrent protections can hardly detect single phase-to-earth faults on non-effectively earthed systems.

It is common practice to apply a dedicated earth fault protection for feeders and other objects in non-effectively earthed systems. Short circuit protections may then use only two overcurrent relays, as shown in Figure 8.5.5, because any multiphase fault will affect at least two phases. The main reason is, of course, an attempt to reduce the cost of the protection system. This argument is valid when the short circuit protection consists of discrete single-phase overcurrent relays. The cost saving is even bigger if the earth fault protection uses a window-type current transformer and it is acceptable to use current transformers in two phases only.

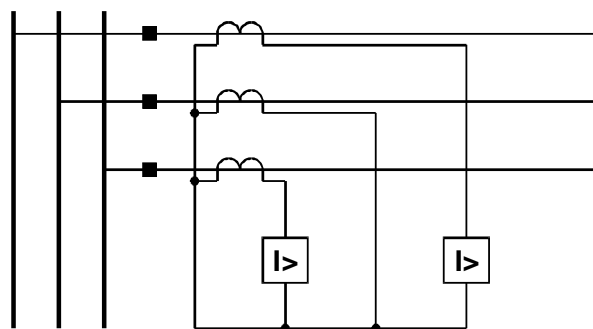

Figure 8.5.5: Two-phase short circuit protection

The dependability of a two-phase short circuit protection is somewhat lower than the reliability of a three-phase short circuit protection. This is, however, not a decisive argument if there is a circuit-local or station-local backup protection.

8.5.1.4 Characteristics of Overcurrent Relays

The overcurrent relay is a single-input device. There are two major types of overcurrent relays, namely: (1) *independent* (definite or constant) *time overcurrent relays* and (2) *dependent* (inverse) *time overcurrent relays*. The operating time of an independent time overcurrent relay is (almost) independent of the value of the input current as long as the value is well above the operating (pickup or start) current. An independent time overcurrent relay is often combined with a time (delay) relay to form a simple protection system that can be coordinated with other protection systems. The operating time of a dependent time overcurrent relay is dependent of the value of the input current as long as the value is somewhat above the operating (pickup or start) current.

The secondary current from a current transformer energizes the relay. The primary current of the current transformer flows to the protected object. The relay has operated when the normally open (NO) trip contact has closed. The closure of the trip contacts energizes the trip coil of at least one circuit breaker. The trip circuit consists of a DC-battery, closing contacts, wires to the circuit breaker and the trip coil of the circuit breaker.

8.5.1.4.1 Independent Time Overcurrent Relays

Figure 8.5.6 shows the operating characteristic of an independent time overcurrent relay. The relay operates when the magnitude of the energizing current exceeds the pickup value. The operating time for currents higher than the pickup value is essentially independent of the magnitude of the energizing current. The operating time for currents lower than the pickup value is essentially infinite, that is, the relay does not operate.

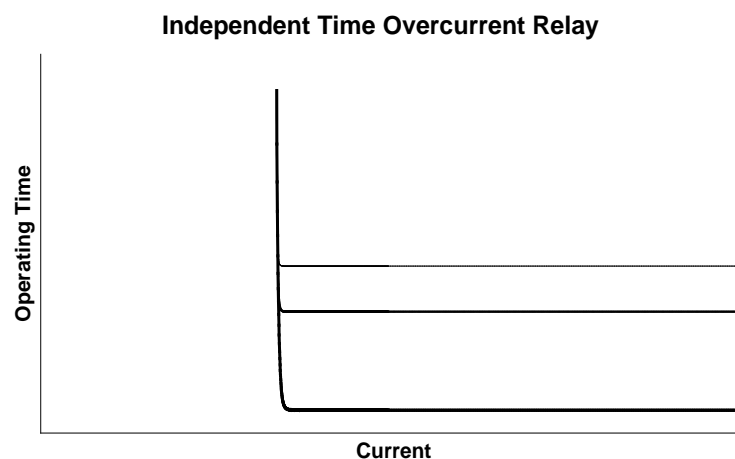

Figure 8.5.6: Characteristic of an independent time overcurrent relay

The independent time overcurrent relay Figure 8.5.6 is combined with two time delay relays to form a protection system that can be coordinated with other protection systems.

8.5.1.4.2 Dependent Time Overcurrent Relays

Figure 8.5.7 shows the operating characteristic of a dependent time overcurrent relay. The relay operates when the magnitude of the energizing current exceeds the pickup value. The operating time for currents higher than the pickup value depends on the magnitude of the energizing current. The operating time for currents lower than the pickup value is essentially infinite, that is, the relay does not operate. The relay has operated when the normally open (NO) trip contact has closed.

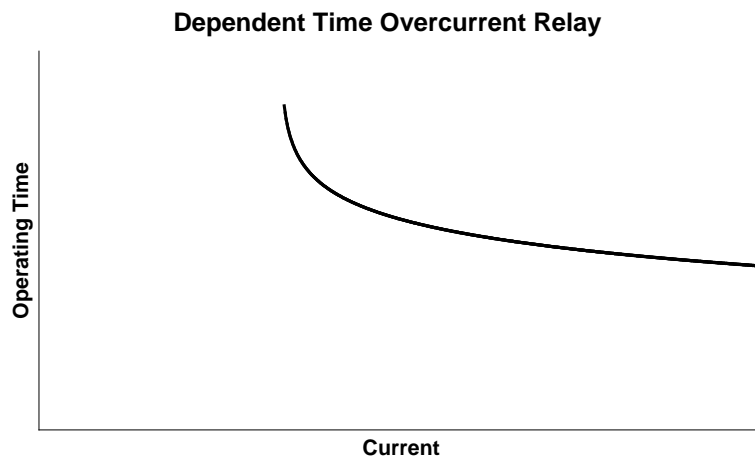

Figure 8.5.7: Characteristic of a dependent time overcurrent relay

There are many types of dependent time relays originating from the different types of design of the electro-mechanical relay in the early 2000s. The most common characteristics are: (1) normal inverse, (2) very inverse, (3) extremely inverse and (4) long-time inverse. Figure 8.5.8 shows the time-current characteristics of these for dependent time overcurrent relays.

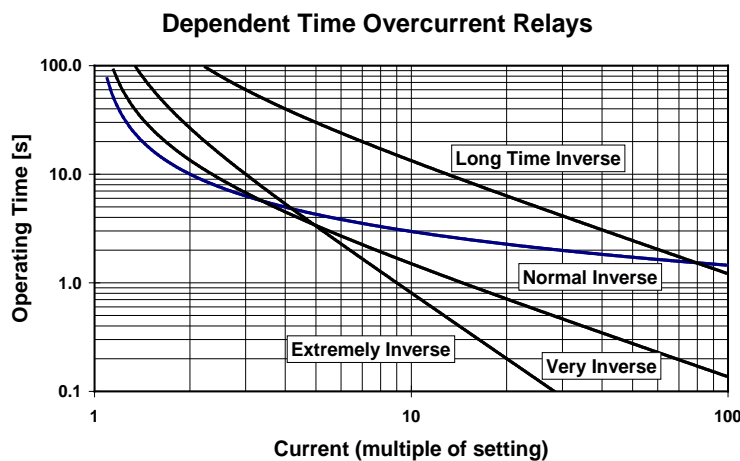

Figure 8.5.8: Characteristics of dependent time overcurrent relays

Note that the relays of all four types will have a *time multiplier setting* (TMS) that makes it possible to change the operating time for a given value of the input current.

Normal Inverse Overcurrent Relays

Figure 8.5.9 shows the time-current characteristic of a normal inverse overcurrent relay as specified in IEC255-4 and BS142-1983.

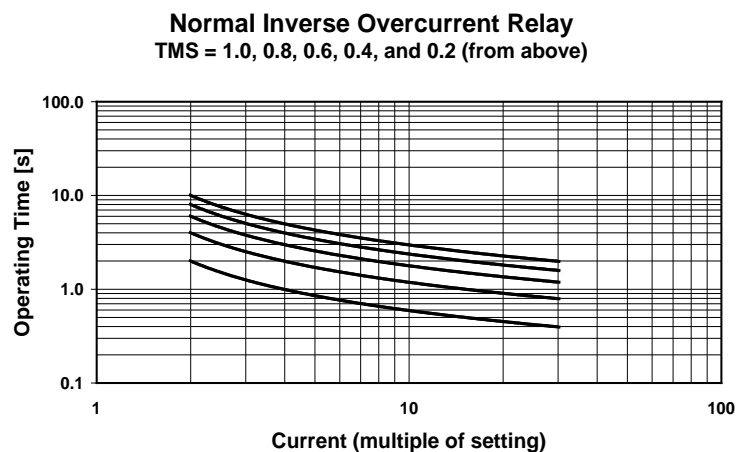

Figure 8.5.9: Characteristic of a normal inverse overcurrent relay

The accuracy of the operating time may range from 5 to 7.5% of the nominal operating time as specified in the relevant norms. The uncertainty of the operating time and the necessary operating time may require a grading margin of 0.4 to 0.5 seconds.

Very Inverse Overcurrent Relays

Very inverse overcurrent relays are particularly suitable if the short-circuit current drops rapidly with the distance from the substation. Figure 8.5.10 shows the time-current characteristic of a very inverse overcurrent relay.

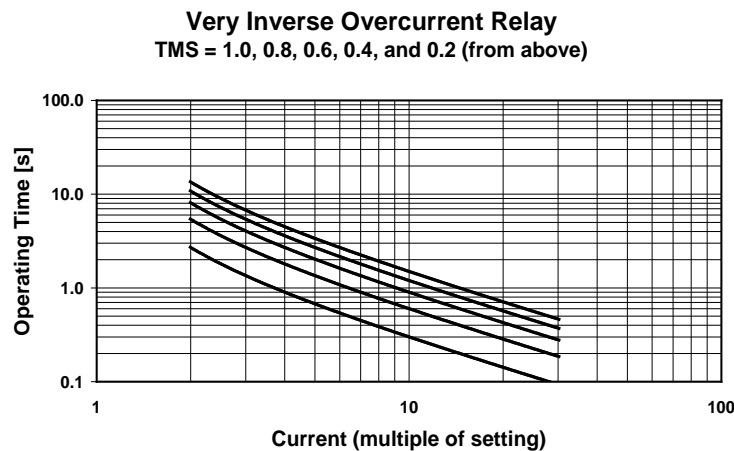

Figure 8.5.10: Characteristic of a very inverse overcurrent relay

The grading margin may be reduced to a value in the range from 0.3 to 0.4 seconds when overcurrent relays with very inverse characteristics are used.

Extremely Inverse Overcurrent Relays

The operating time of a time overcurrent relay with an extremely inverse time-current characteristic is approximately inversely proportional to the square of the current. Figure 8.5.11 shows the time-current characteristic of an extremely inverse overcurrent relay.

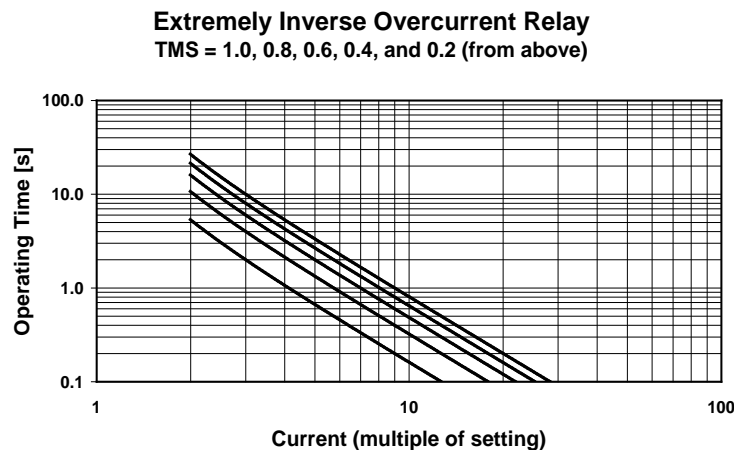

Figure 8.5.11: Characteristic of an extremely inverse overcurrent relay

The use of extremely inverse overcurrent relays makes it possible to use a short time delay in spite of high switching-in currents.

Long Time Inverse Overcurrent Relays

Figure 8.5.12 shows the time-current characteristic of a long time inverse overcurrent relay.

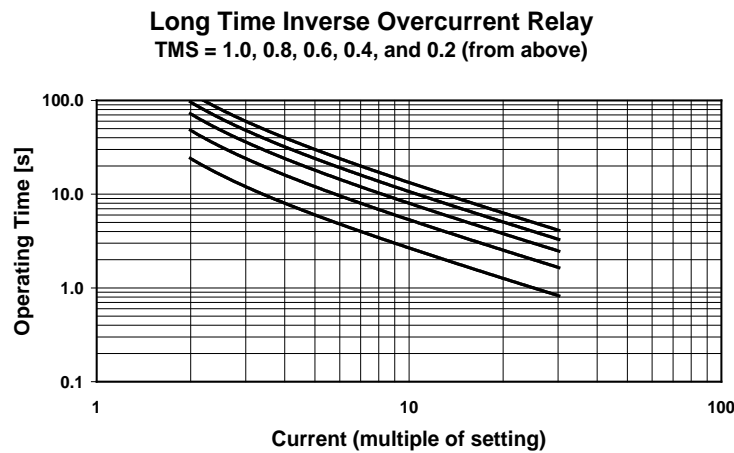

Figure 8.5.12: Characteristic of a long time inverse overcurrent relay

The main application of long time overcurrent relays is as backup earth fault protection.

8.5.1.4.3 *IDMT Overcurrent Relays*

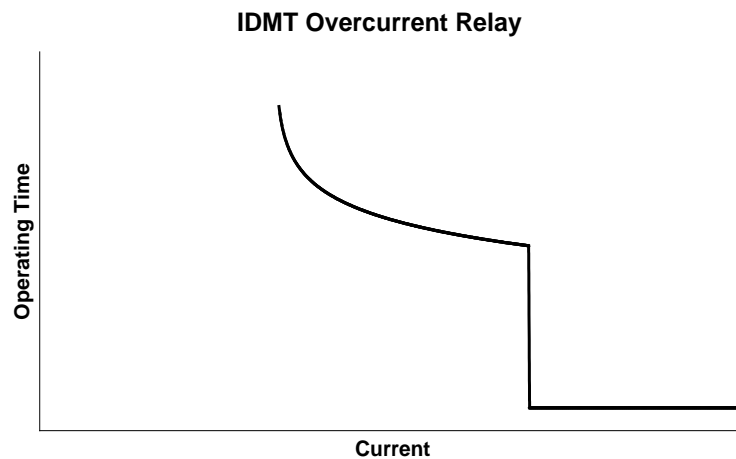

Figure 8.5.13: Characteristic of an IDMT overcurrent relay

8.5.1.5 Blocking-based Overcurrent Protection

One disadvantage of a protection system based on time-graded dependent time overcurrent relays is that the fault clearance time increases towards the feeding substation where the fault current is the heaviest.. It is possible to reduce the fault clearance time if a binary teleprotection channel from the downstream relay can be provided. Figure 8.5.14 shows such a protection system. In the example, a short circuit occurs at F on the feeder stating at B.

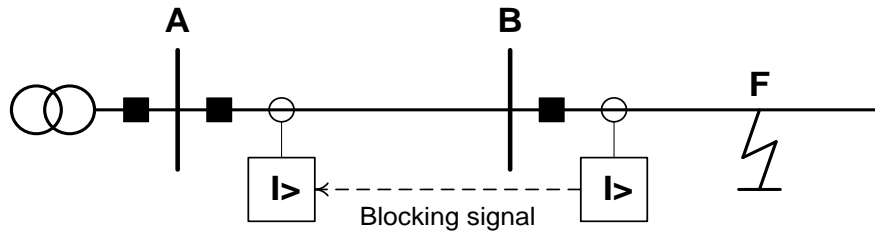

Figure 8.5.14: Blocking-based overcurrent protection

The overcurrent relay at A detects the fault and operates with a short delay unless it receives a blocking signal from the overcurrent relay in substation B. The overcurrent relay in substation B also detects the short circuit and sends a blocking signal to the overcurrent relay in substation A. The overcurrent relay in substation A is blocked from issuing a trip signal. If a short circuit occurs on the feeder between substation A and substation B, the overcurrent relay in substation B does not operate because the fault is upstream from substation B and fault current is fed only from substation A. Therefore, the overcurrent relay in substation A does not receive any blocking signal and operates with a short delay that may range from 0.15 to 0.20 seconds.

If a short circuit occurs at F on the feeder downstream substation B and the overcurrent relay at B fails to operate, the overcurrent relay in substation A does not receive any blocking signal and operates with the short delay.

If a short circuit occurs at F on the feeder downstream substation B and the overcurrent relay at B fails to operate, the overcurrent relay in substation A does not receive any blocking signal and operates with the short delay.

If (1) a short circuit occurs at F on the feeder downstream substation B, (2) the overcurrent relay in substation B operates and (3) the circuit breaker in substation B fails to operate, the overcurrent relay in substation B sends a blocking signal to the overcurrent relay in substation A. In this case, the overcurrent relay in substation A operates with a time delay that is coordinated with the downstream relay in substation B.

The blocking-based overcurrent protection has two salient features: It operates fast for short circuits on the feeder between substation A and substation B. It also provides both relay and breaker failure backup for faults on the feeder downstream of substation B.

8.5.1.6 Parallel Feeders

In parallel feeders running from a source bus S to a load bus L as shown in Figure 8.5.15, it is not possible to set non-directional overcurrent relays so that they provide selective protection of the feeders. If a solid three-phase fault occurs close to the load bus L at F as shown in Figure 8.5.15, all overcurrent relays sense the same current and independent time overcurrent relays will operate if the energizing current is higher than the pickup current. Dependent time relays will also operate if the energizing current is higher than the

pickup current but the operating time will differ in a random way. Non-directional overcurrent relays cannot provide selective protection of parallel feeders.

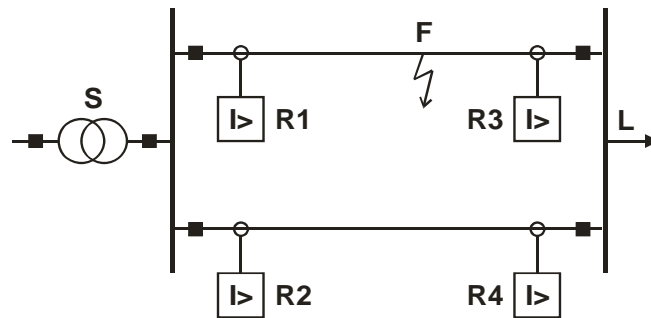

Figure 8.5.15: Overcurrent protections applied to parallel feeders

With this type of system configuration, it is necessary to apply directional relays at the load bus L. It is also necessary to grade them with the non-directional relays at the sending end S to ensure selective protection of both feeders. The directional elements of relay R3 and R4 must look into the protected feeder. The pickup current of the directional relays R3 and R4 must be lower than the pickup current of the non-directional relays R1 and R2. The operating time of the directional relays R3 and R4 must be shorter than the operating time of the non-directional relays R1 and R2. Their continuous thermal rating must not be exceeded during normal operation and when one feeder is out of service.

8.5.1.7 Directional Overcurrent Relays

The overcurrent relay should operate for fault in the forward direction or trip direction and the relay should not operate for fault in the reverse or non-tripping direction. It is sometimes necessary to use a directional overcurrent relay instead of a non-directional relay to attain this goal. The directional overcurrent relay is a dual-input device. One input signal is the current from the current transformer. The other input is a polarizing quantity. It is often a voltage but may alternatively be a current. A directional overcurrent relay consists of a directional element and a level detector.

Figure 8.5.16 shows the operating characteristic of a directional overcurrent relay. The polarizing quantity lies along the real axis in Figure 8.5.16.

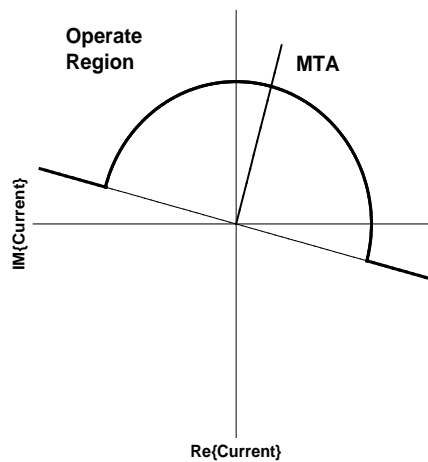

Figure 8.5.16: Characteristic of a directional overcurrent relay

Two settings determine the characteristics of a directional overcurrent relays. The first is the pickup current, which determines the radius of the semi-circle in Figure 8.5.16. The second is the maximum torque angle (MTA) of the directional element. The directional overcurrent relay operates if the tip of the current vector falls outside the semi-circle and above the line perpendicular to the MTA-line in Figure 8.5.16.

8.5.1.8 Longitudinal Differential Protection Systems

Figure 8.5.17 shows a longitudinal differential protection system for a distribution line. The currents at both ends of the distribution line energize the longitudinal differential relay. A telecommunication system transmits information between the protection equipment at each end of the distribution line.

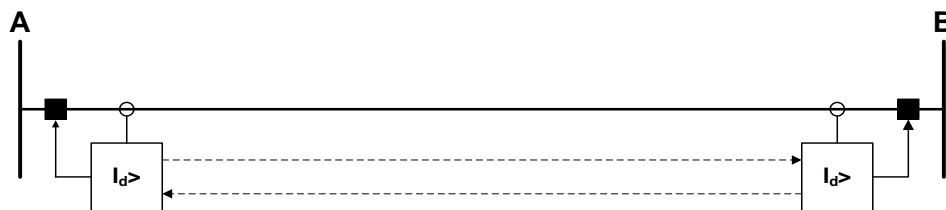

Figure 8.5.17: Differential protection

This kind of protection operates when the differential current I_d exceeds a certain value. Equation (8.5.1) defines the operating condition for a current differential protection system.

$$I_d = |I_L + I_R| > f(I_s) \tag{8.5.1}$$

Here $f(\cdot)$ is a function of the stabilizing current. Equation (8.5.2) defines the stabilizing current I_s .

$$I_s = |I_L| + |I_R| \tag{8.5.2}$$

There are many kinds of functions, and equation (8.5.3) gives an example.

$$f(I_s) = \max(I_t, k \cdot I_s) \tag{8.5.3}$$

Here I_t is the minimum operating current and k is the degree of stabilization. Figure 8.5.18 shows a typical characteristic of a differential protection.

The differential current I_d is close to zero during normal operation. It is also close to zero at external faults. The differential current I_d will be equal to the total fault current in case of an internal fault.

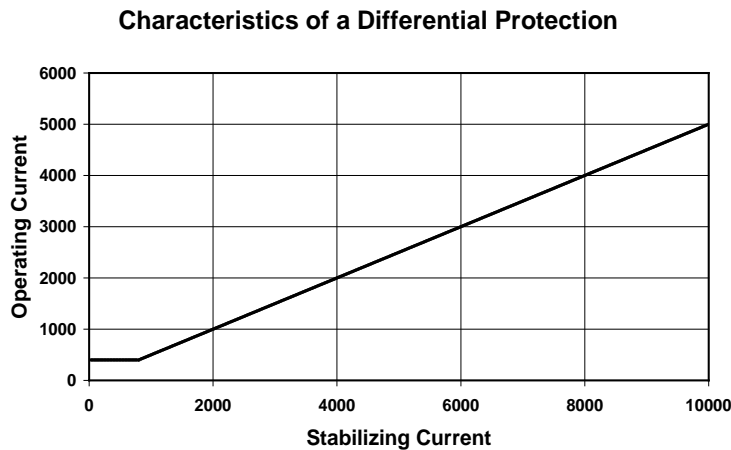

Figure 8.5.18: Operating characteristic of a differential protection

It is possible to protect very short lines by means of current differential protections using pilot wires. Optical fibers and digital radio links make it possible to use differential protection on long lines, see [8.5.1], [8.5.2], [8.5.3] and [8.5.4]. The bandwidth of such teleprotection channels makes it possible to use phase-segregated current differential protections.

8.5.1.9 Thermal Overload Protection

A thermal overload relay is used to protect the object against a current that after some time determined by the thermal inertia of the protected object increases the temperature beyond the acceptable steady-state operating temperature. The owner of the protected object may want to exploit the temporary overload capability of the protected object.

The application of thermal overload protection is illustrated with an example, where two underground cables supply an industrial customer with a variable load. Initially the load is supplied by one cable only and it is loaded up to its maximum capability as shown in Figure 8.5.19.

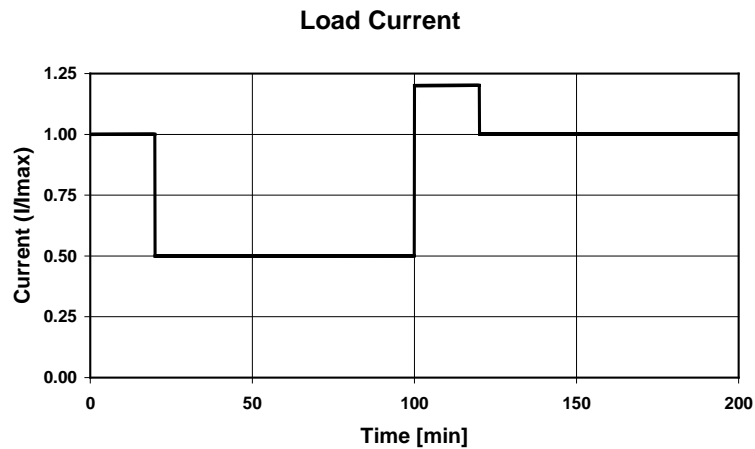

Figure 8.5.19: Assumed load current

Figure 8.5.20 shows the cable conductor temperature. It has reached the assumed maximum temperature (here 80°C), because the assumption is that the load current has been constant and equal to the maximum current for a long time (several hours).

At $t=20$ minutes, the parallel cable is switched in and the load current drops to 50% of the maximum current as shown in Figure 8.5.19. The heating of the cable drops to 25%, proportional to I^2 if the conductor resistance is constant, and the temperature of the cable conductor starts to decrease. The rate of change of the cable temperature is, of course, dependent on the type of cable and the properties of the surrounding soil. The final value of the temperature is the sum of the ambient temperature and the temperature increase caused by the Joule losses. The ambient temperature is assumed to be 20°C, which means that the temperature rise caused by the Joule losses amounts to 60°C. The temperature rise caused by the Joule losses decreases to 15°C when the load current drops to 50% of maximum current. This means that the final cable conductor temperature should be about 35°C. The cable conductor temperature is close to this value at $t=100$ minutes as shown in Figure 8.5.20.

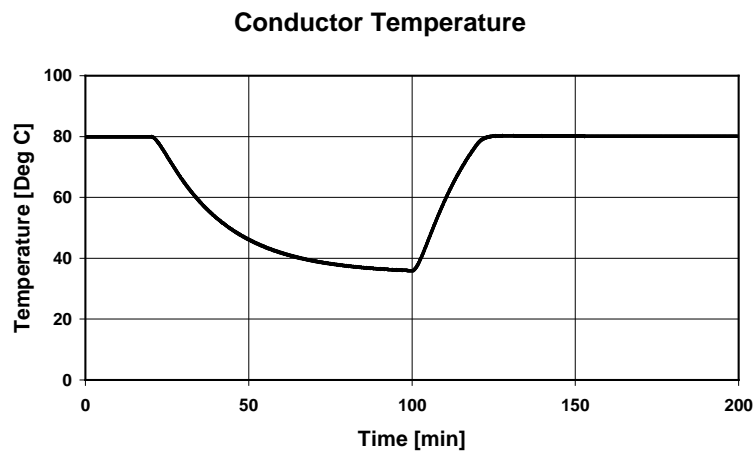

Figure 8.5.20: Temperature response

At $t=100$ minutes, the load increases in the industry and the parallel cable is inadvertently disconnected. The load current increases like a step from 50% to 120% of maximum as shown in Figure 8.5.19. The cable conductor temperature starts to increase and is expected to reach a temperature well above 100°C unless the load is reduced.

At $t=120$ minutes, the parallel cable is switched in again and the current drops to 100% of maximum current as shown in Figure 8.5.19. The rate of change of the cable conductor then becomes essentially equal to zero and the temperature settles at the maximum temperature as shown in Figure 8.5.20.

A thermal overload protection should preferably have two operating values of the temperature; one lower that will issue an alarm and one higher that will trip the circuit breaker and disconnect the overloaded object. It is even better to use the operating signal to disconnect the non-essential load to avoid overheating and disconnection of the essential load.

References

- [8.5.1] Einarsson, T.; Wennerlund, P.; Cederblad, L.; Lindahl, S. & Holst, S.: "Experiences of Current Differential Protections for Multi-Terminal Power Lines Using Multiplexed Data Transmission Systems," Report 34-203, 35th CIGRE Session, Paris, France, 28th August - 3rd September 1994.
- [8.5.2] Kwong, W.S., Clayton, M.J. & Newbould, A.: "A Microprocessor-based Current Differential Relay for Use with Digital Communication Systems," Third International Conference on Developments in Power-System Protection, IEE Conference Publication No. 249, pp. 65-69, 17-19 April 1985.
- [8.5.3] Kwong, W.S.; Clayton, M.J.; Newbould, A. & Downes, J.A.: "A microprocessor-based current differential relay for use with digital communication systems its design and field experience," Report 34-02, 31st CIGRE Session, Paris, August-September 1986.
- [8.5.4] Sun, S.C. & Ray, R.E.: "A Current Differential Relay System Using Fiber Optics Communications," IEEE Transactions on Power Apparatus and Systems, vol. PAS-102, no. 2, pp. 410-419, February 1983.

Document revision history

Document revision/date	History
A / 07 October 2010	First revision

Disclaimer and Copyrights

The information in this document is subject to change without notice and should not be construed as a commitment by ABB Oy. ABB Oy assumes no responsibility for any errors that may appear in this document.

In no event shall ABB Oy be liable for direct, indirect, special, incidental or consequential damages of any nature or kind arising from the use of this document, nor shall ABB Oy be liable for incidental or consequential damages arising from use of any software or hardware described in this document.

This document and parts thereof must not be reproduced or copied without written permission from ABB Oy, and the contents thereof must not be imparted to a third party nor used for any unauthorized purpose.

The software or hardware described in this document is furnished under a license and may be used, copied, or disclosed only in accordance with the terms of such license.

Copyright © 2010 ABB Oy

All rights reserved.

Trademarks

ABB is a registered trademark of ABB Group. All other brand or product names mentioned in this document may be trademarks or registered trademarks of their respective holders

Contact information

ABB Oy, Distribution Automation

P.O.Box 699

Visiting address: Muottitie 2A

FI-65101 Vaasa, FINLAND

Phone: +358 10 22 11

Fax: +358 10 22 41094

www.abb.com/substationautomation

